

# Electric Vehicle Charging Station

## Installation Manual

Cat. Nos. EV320, EV32W, EV480, EV48W, EV800, EV80W

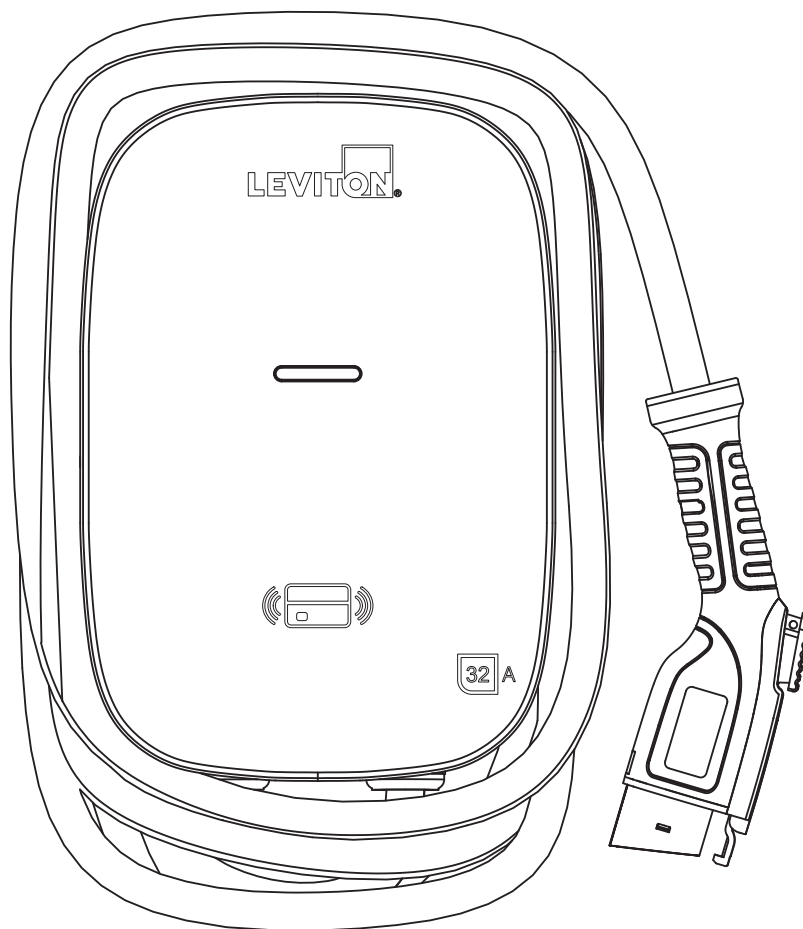

**32A / 48A / 80A EVSE**



## TABLE OF CONTENTS

1	Warnings .....	4
2	Safety and Specifications .....	5
3	Tools Needed .....	6
4	Basic Interface .....	7
5	Dimensions .....	8
6	Status Light Key .....	9
	6.1 Status Description of the Charger Indication Light .....	9
7	Installation .....	10
	7.1 Wiring .....	10
	7.2 Wall-Mounted Bracket Installation.....	11
8	Operating Instructions .....	12
	8.1 Operating Procedures.....	12
	8.2 To Restrict User Activation via RFID Card .....	13
9	Error and Warning Messages .....	15
10	Maintenance and Repair .....	16
	10.1 Daily Maintenance .....	16
11	Standard Statements and Warranty .....	17

# 1 WARNINGS

## Safety Instructions

**WARNING:** TO AVOID FIRE, SHOCK OR DEATH, TURN OFF POWER at the circuit breaker or fuse, and test that the power is off before wiring! Do not remove circuit protective devices or any other component until power is turned off.

**WARNING:** TO AVOID FIRE, SHOCK, DEATH, OR DAMAGE TO THE CHARGER, carefully read the charging instructions in your vehicle's manual before charging and heed the following warnings:

- Risk of electric shock. Do not remove cover or attempt to open the enclosure of the device. No user serviceable parts inside.
- Risk of explosion. Do not install or use the charger near flammable, explosive, corrosive, or combustible materials, chemicals, or vapors.
- This device should be installed, adjusted, and serviced by qualified electrical personnel familiar with the construction and operation of this type of charger and the dangers involved.
- The device is designed only for vehicles that are compatible with the SAE J1772 Level 2 charging standard.
- Do not use the charger if it is defective, appears cracked, frayed, broken, or damaged.
- Do not use the charger when you are in the vehicle, or the charger is exposed to severe rain, snow, or other severe weather.
- When transporting the charger, handle with care and do not drag or step on the device.
- Do not touch the charging connector terminal with sharp metallic objects for preventing damage.
- Do not forcefully pull the charging cable, damage it with sharp objects, put fingers, or insert foreign objects into any part of the charging connector.
- Connect only to a circuit providing branch circuit overcurrent protection in accordance with the National Electrical Code, ANSI/NFPA 70 (United States), the Canadian Electrical Code, Part I, C22.1. Canada), or NOM-001-SEDE (Mexico).

Model	Circuit Breaker/Fuse Rating
EV320, EV32W	40A
EV480, EV48W	60A
EV800, EV80W	100A

Incorrect installation and testing of the charger could potentially damage either the vehicle's battery and/or the device itself. Any resulting damage is excluded from the warranty for the device

Ensure that the charging cable is well positioned during charging so it will not be stepped on, tripped over, or subjected to damage or stress.

The device is designed only for vehicles that are compatible with the SAE J1772 Level 2 charging standard.

## 2 SAFETY AND SPECIFICATIONS

### Design Safety Standards

UL2594: Electric Vehicle Supply Equipment

UL 2231-1: Personnel Protection Systems for Electric Vehicle (EV) Supply Circuits: General Requirements

UL 2231-2: Personnel Protection Systems for Electric Vehicle (EV) Supply Circuits: Particular Requirements for Protection Devices for Use in Charging Systems

UL 2251: Plugs, Receptacles and Couplers for Electric Vehicles

UL 62: Flexible Cords and Cables

UL 991: Tests for Safety-Related Controls Employing Solid-State Devices

UL 1998: Software in Programmable Components

NFPA 70 Article 625: National Electrical Code, Electric Vehicle Charging System

UL840 (Clearance and Creepage)

### Specifications

Model Name	EV320, EV32W, EV480, EV48W, EV800, EV80W
Rated Input Voltage	200-240 VAC / Single Phase
Rated Output Current	32A / 48A / 80A
AC Power Frequency	50/60 Hz
Input Protection	UVP, OVP, RCD, SPD, Ground Fault Protection
Output Protection	OCP, OTP, Control Pilot Fault Protection
Output Interface	SAE J1772 AC Charging Connector
Storage Temperature	-40°F(-40°C) to + 158°F(70°C)
Operation Temperature	-22°F(-30°C) to + 122°F(50°C)
Relative Operation Humidity	95% RH Maximum
Relative Storage Humidity	95% RH Maximum
RJ45 Cable Inlet - LAN Version or Wi-Fi	10M / 100M Base-T
Wi-Fi Function - Wi-Fi Version	802.11 b/g/n
Cable Length	18 Ft.
Protection Level	IK08 & IP54
Installation Type	Wall mount or pedestal mount
Altitude	≤ 2000 m
Weight	EV320 and EV32W: 5.5 ± 0.5kg EV480 and EV48W: 6.5 ± 0.5kg EV800 and EV80W: 7.5 ± 0.5kg
Dimensions	360.50 mm. x 249.94 mm. x 86.94 mm.
Status Indication	Red, Green, Blue LED

### 3 TOOLS NEEDED

#	Product Name	Quantity
1	AC Charger (With Charging Cable)	1
2	User Manual	1
3	Wall Mounted Bracket	1
4	M5 teeth screws	2
5	M6 Hexagonal Expansion Screws	4
6	Standard RFID Card	2
7	Administrator RFID card	1

### Tools required before installing the Wall-Mounted charger:

- Wire stripper
- Phillips screwdriver
- Adjustable Wrench
- Voltmeter or digital multimeter (for measuring AC voltage at the installation site)
- Level
- Pencil or marker
- Drill

1

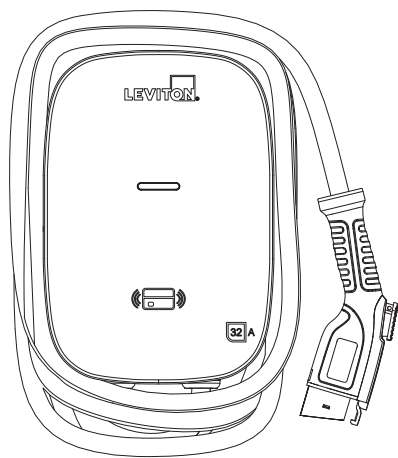

2

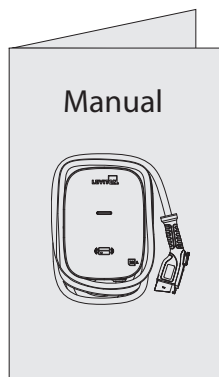

3

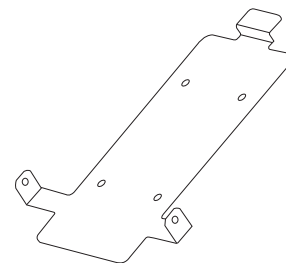

4

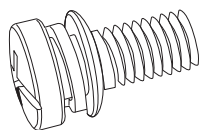

5

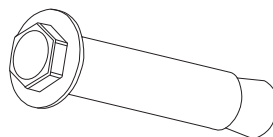

6

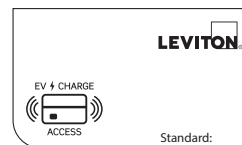

7

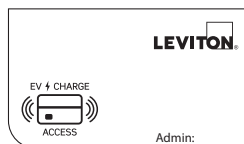

WEB VERSION

## 4 BASIC INTERFACE

**EV320**  
**EV32W**  
**EV480**  
**EV48W**  
**EV800**  
**EV80W**

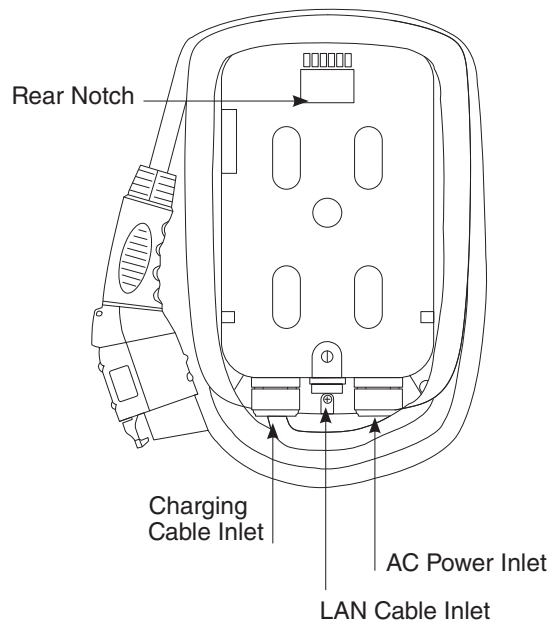
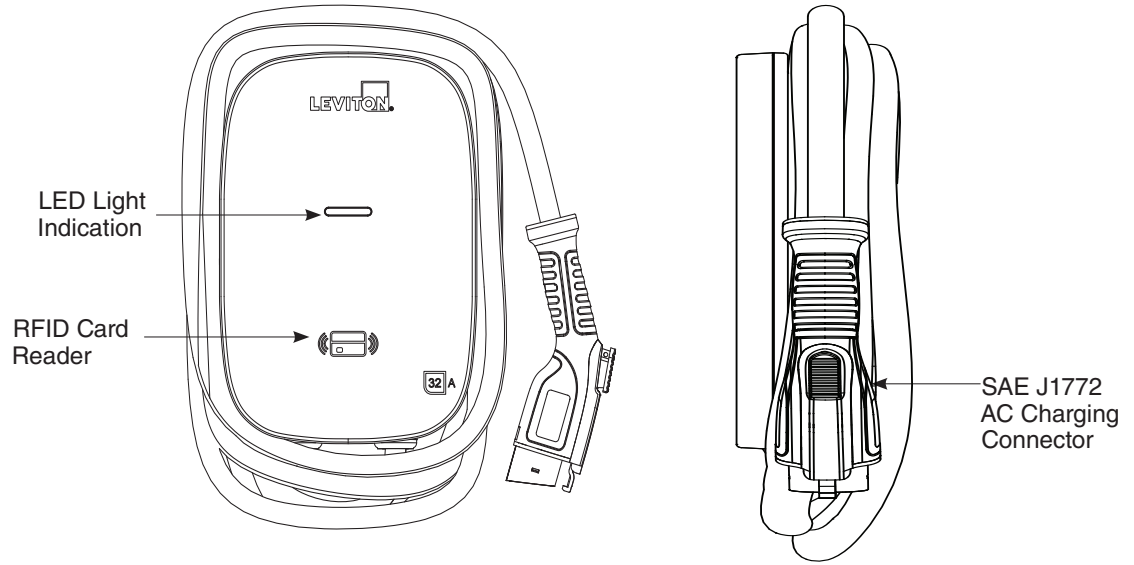

## 5 DIMENSIONS



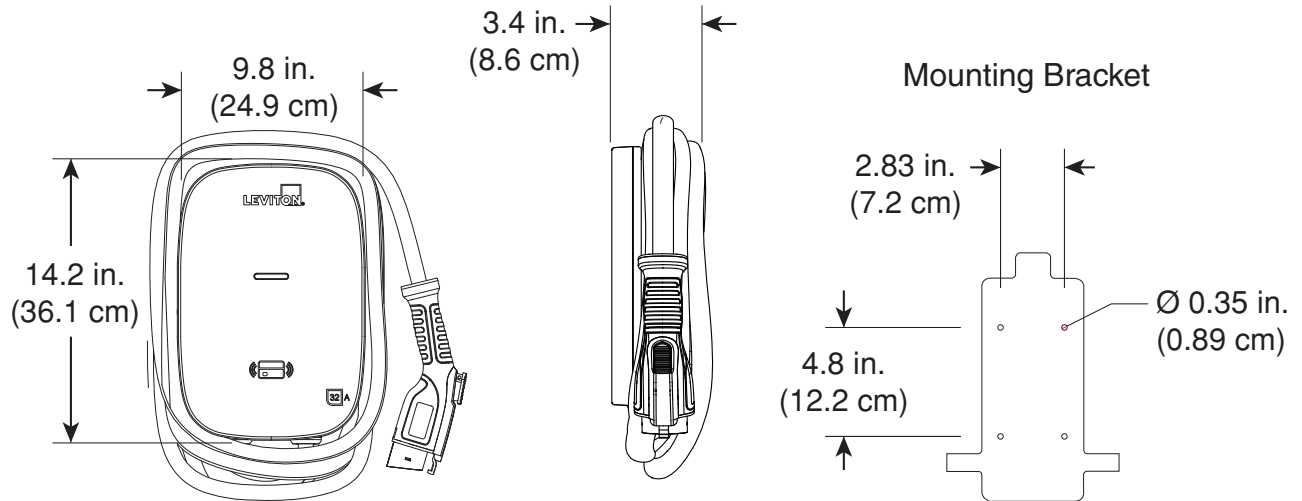

Main Size of Charger - EV320, EV32W, EV480, EV48W, EV800 and EV80W





## 6 STATUS LIGHT KEY

### 6.1 Status Description of the Charger Indication Light

Status of Charger Indication Light	
 Blue Light	Standby - Blue Light The READY light stays steady in standby mode.
 Green Light	Waiting for Charge - Green Light After the vehicle connector is connected to the vehicle inlet, the CHARGE light is constantly lit.
 Green Light Flashing	Charging - Green Light Flashing The CHARGE light flashes while charging
 Red Light	Fault - Red Light The red light is lit while fault. Please refer to section 9 “Error and Warning Messages” for detailed information.
 Blue Light Flashing	MyLeviton Setup Mode - Blue Light Flashing (EV32W, EV48W and EV80W only)

#### Safety Requirements:

- Be sure to preview the user manual and ensure local building and electrical codes are reviewed before installing the AC charger.
- The AC charger should be installed by a qualified technician according to the user manual and local safety regulations.
- Use appropriate protection when connecting to the main power distribution cable.
- Type B, C or D breaker with the rating current for table should be installed in the upstream AC distribution box.
- Disconnect switch for each ungrounded conductor of AC input shall be provided by others in accordance with the National Electrical Code, ANSI/NFPA 70.

## 7 INSTALLATION

### 7.1 Wiring

#### 240V Single Phase -

CAUTION: The two phases used must each measure 120V to Ground. Earth ground must be connected to neutral at only one point, usually at the breaker panel.

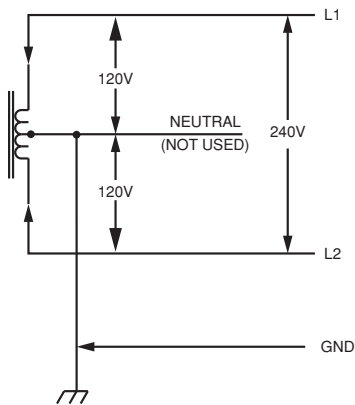

#### 208V 3-Phase, Wye-Connected -

CAUTION: The 208V feed is from a y-connection power grid, and the AC charger can connect to L1 and L2, L2 and L3, L1 and L3. Earth ground must be connected to neutral at only one point, usually at the breaker panel. Leave the unused leg open. Do not connect it to a Neutral bar, or to ground. Be sure the center point is Earth ground somewhere in the system.

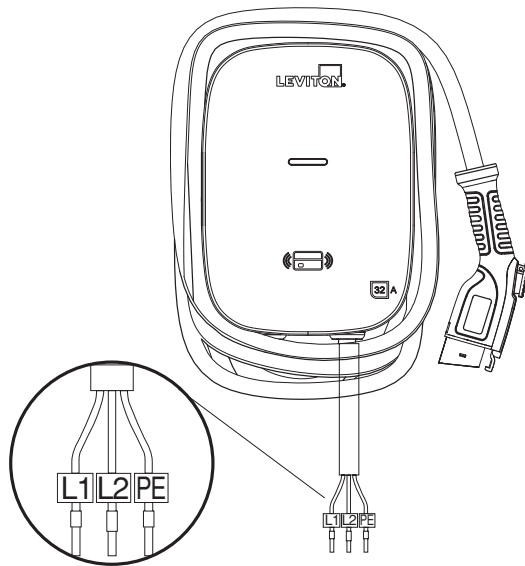
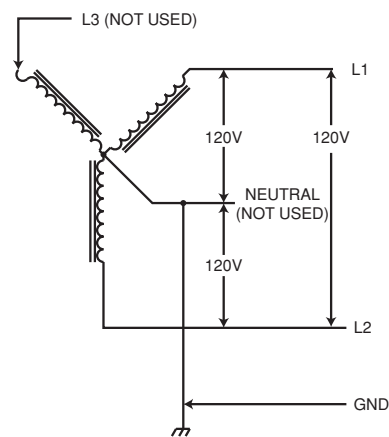

Circuit Breaker Options Table

Circuit Breaker Options Table			
Output Amperage Amps	32A	48A	80A
Circuit Breaker Options Amps	40A	60A	100A

## 7 INSTALLATION

### 7.2 Wall-Mounted Bracket Installation

1.

- Set the positions of the four (4) screw holes and drill them, with a diameter of .33 in. (8.5 mm) and a depth of 2.05 in. (52 mm).
- Use 4 sets expansion screw and M6 screw to fix the wall-mounted bracket on the wall.
- Use anchors appropriate for the wall substrate on which you are mounting.

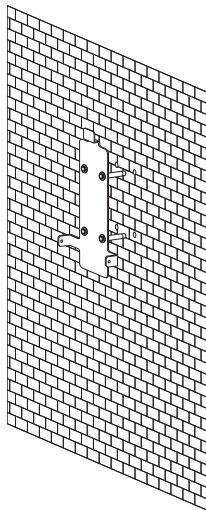

2.

- Align the rear notch of charger into the wall-mounted bracket and fit the screw holes of the right and left side.

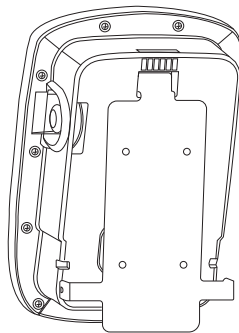

3.

- Fix two M5 screws to complete the installation.







## 8 OPERATING INSTRUCTIONS

### 8.1 Operating Procedures

- User authorization
- Connect to Vehicle Charging Inlet
- Charging Message
- Charging completed

**NOTE:** Device may need to be activated or de-activated with RFID cards.

**NOTE:** RFID access control is disabled by default on all units. See section 8.2 for operation with RFID enabled.

Operating Steps	
 READY	1. Standby - Blue Light
	2. Plug the charging connector into the vehicle charging inlet. <b>NOTE:</b> If you have activated RFID on your charging station, you must tap the RFID card to the station and then plug in within 2 minutes.
 CHARGE	3. Charging The green light flashes automatically, which indicates the device is charging. <b>NOTES:</b> <ul style="list-style-type: none"><li>• If the red light (FAULT) is lit, plug-in the vehicle connector again.</li><li>• If red light is still lit, please refer to “Error and Warning Messages.”</li></ul>
	4. Charging Finished When charging is finished, the green light stops flashing. Unplug the connector to complete the charging session.

## 8 OPERATING INSTRUCTIONS

### 8.2 To Restrict User Activation via RFID Card

#### Activation and Usage

**NOTE:** Activation of RFID access control is **ONLY** required when access to charging will be restricted only for RFID card holders. If no restriction is required (open charging) this step is **NOT** required.

#### 1. Identify Your Card

- All units come with 1 administrative (admin) card and 2 standard cards as marked on the cards
- Admin cards are used to **activate** RFID access control and should be kept by charger owner
- Standard cards are used to **enable** charging by users

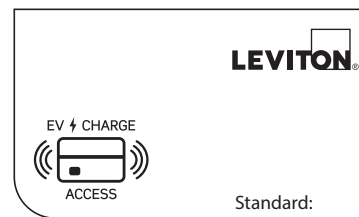
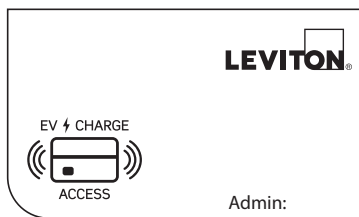

#### 2. Activate RFID Access Control

**CAUTION:** Once enabled, RFID access control cannot be disabled. If you prefer to keep this as an unrestricted unit, do not activate this card.

- To enable RFID access control, hold the admin card to the RFID sensor image on the front of the charger until you hear a beep. RFID access control is now enabled.

## 8 OPERATING INSTRUCTIONS

3. To enable charging with RFID card(s)

- Charging can be enabled with your standard RFID cards

### 1. Enable charging.

**TAP** your RFID card to the front of the charger over the image of the RFID. The POWER light will turn solid green when the RFID card has enabled the unit to charge.

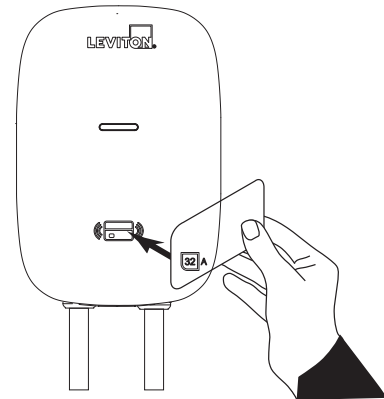

### 2. Start charging.

Press and hold the black button on the top of the charge plug and insert it into the inlet on your car. Charging starts automatically. The CHARGE light will flash green.

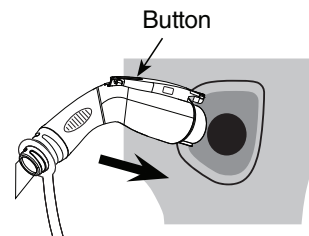

### 3. How to stop and restart.

To stop charging, press black button on top of charge plug to remove plug. To restart charging, tap your RFID card, press black button and reinsert.

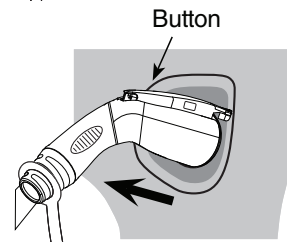

### 4. After charging is complete.

**NOTE:** When charging is complete, loop charging cable over station to prevent tripping hazard.

**NOTE:** If the charging station is not being used for an extended period of time, it should be turned OFF.

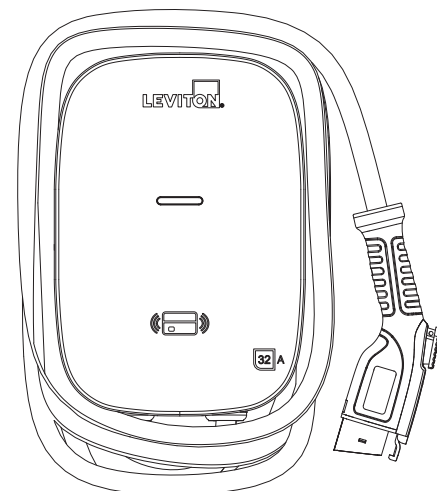

## 9 ERROR AND WARNING MESSAGES

Status	Red	Remark
Emergency Fault	Constantly Bright	Power Cycle
Input OVP	1 flash followed by 3 second pause	Auto Recover
Input UVP	2 flashes followed by 3 second pause	Auto Recover
Output OCP	3 flashes followed by 3 second pause	Auto Recover (Pull out the charging connector)
OTP	4 flashes followed by 3 second pause	Auto Recover
RCD Abnormal	5 flashes followed by 3 second pause	Auto Recover (Pull out the charging connector)
Ground Fault	6 flashes followed by 3 second pause	Auto Recover
Control Pilot Fault	7 flashes followed by 3 second pause	Auto Recover (Pull out the charging connector)
Relay Fault	8 flashes followed by 3 second pause	Contact Customer Service
RCD Self-Test Fault	9 flashes followed by 3 second pause	Contact Customer Service
Relay Self-Test Fault	10 flashes followed by 3 second pause	Contact Customer Service
Meter Fault	Keeps Blinking	Contact Customer Service

## 10 MAINTENANCE AND REPAIR

### 10.1 Daily Maintenance

#### WARNING

- Avoid moisture or water in the charger. If there is water or moisture, it is necessary to immediately power off to avoid immediate danger, and notify professional personnel to carry out maintenance before next use.

#### CAUTIONS

- Keep the charger clean and in an area with low humidity.  
Do not install it in an environment near the sea, with high oil, high humidity, or high dust.
- If there is any damage or dirt on the vehicle connector, charging cable, or vehicle connector holder, please contact the maintenance personnel immediately.
- Please use the charger properly. Do not hit or press hard on the case or place heavy objects on the charger. If the case is damaged, please contact a professional technician.
- Avoid placing the charger near hot objects and at high temperature locations and away from dangerous substances such as flammable gases and corrosive materials.



## 11 STANDARD STATEMENTS AND WARRANTY

### FCC STATEMENT:

This device complies with Part 15 of the FCC Rules and ISSED License-exempt RSS standard(s). Operation is subject to the following two conditions: (1) This device may not cause harmful interference, and (2) This device must accept any interference received, including interference that may cause undesired operation. Changes or modifications not expressly approved by Leviton could void the user's authority to operate the equipment.

These limits are designed to provide reasonable protection against harmful interference in a commercial installation. This equipment generates, uses and can radiate radio frequency energy and, if not installed and used in accordance with the instructions, may cause harmful interference to radio communications. However, there is no guarantee that interference will not occur in a particular installation. If this equipment does cause harmful interference to radio or television reception, which can be determined by turning the equipment off and on, the user is encouraged to try to correct the interference by one or more of the following measures:

- Reorient or relocate the receiving antenna.
- Increase the separation between the equipment and receiver.
- Connect the equipment into an outlet on a circuit different from that to which the receiver is connected.
- Consult the dealer or an experienced radio/TV technician for help.

This Class A digital apparatus complies with Canadian CAN ICES-3(A)/NMB-3(A).

### FCC SUPPLIER'S DECLARATION OF CONFORMITY:

This device complies with part 15 of the FCC Rules. Operation is subject to the following two conditions: (1) This device may not cause harmful interference, and (2) this device must accept any interference received, including interference that may cause undesired operation.

### TRADEMARK DISCLAIMER:

Leviton and the Leviton logo are trademarks of Leviton Manufacturing Co., Inc. Use herein of third party trademarks, service marks, trade names, brand names and/or product names are for informational purposes only, are/may be the trademarks of their respective owners; such use is not meant to imply affiliation, sponsorship, or endorsement.

Leviton Manufacturing Co., Inc.  
201 North Service Road, Melville, NY 11747

Visit Leviton's website at [www.leviton.com](http://www.leviton.com).

© 2024 Leviton Manufacturing Co., Inc. All rights reserved.

Specifications and price subject to change at any time without notice.

### FOR CANADA ONLY

For warranty information and/or product returns, residents of Canada should contact Leviton in writing at **Leviton Manufacturing of Canada ULC** to the attention of the **Quality Assurance Department, 165 Hymus Blvd, Pointe-Claire (Quebec), Canada H9R 1E9** or by telephone at **1 800 405-5320**.

### LIMITED 2 YEAR WARRANTY AND EXCLUSIONS

Leviton warrants to the original consumer purchaser and not for the benefit of anyone else that this product at the time of its sale by Leviton is free of defects in materials and workmanship under normal and proper use for two years from the purchase date. Leviton's only obligation is to correct such defects by repair or replacement, at its option. **For details visit [www.leviton.com](http://www.leviton.com) or call 1-800-824-3005.** This warranty excludes and there is disclaimed liability for labor for removal of this product or reinstallation. This warranty is void if this product is installed improperly or in an improper environment, overloaded, misused, opened, abused, or altered in any manner, or is not used under normal operating conditions or not in accordance with any labels or instructions. **There are no other or implied warranties of any kind, including merchantability and fitness for a particular purpose,** but if any implied warranty is required by the applicable jurisdiction, the duration of any such implied warranty, including merchantability and fitness for a particular purpose, is limited to two years. **Leviton is not liable for incidental, indirect, special, or consequential damages, including without limitation, damage to, or loss of use of, any equipment, lost sales or profits or delay or failure to perform this warranty obligation.** The remedies provided herein are the exclusive remedies under this warranty, whether based on contract, tort or otherwise.

**For Technical Assistance Call: 1-800-824-3005 (USA Only) or 1 800 405-5320 (Canada Only) [www.leviton.com](http://www.leviton.com)**





