

EMB Hub™ Data Acquisition Server

Cat. No. A8810

Quick Start Guide



1 PRODUCT APPLICATION LIMITATION

READ THESE INSTRUCTIONS BEFORE INSTALLING

- This product is not intended for use in critical applications such as nuclear facilities, human implantable devices or life support. Leviton is not liable, in whole or in part, for any claims or damages arising from such uses.

CAUTION

This product is not intended for life safety applications.

Do not install this product in hazardous or classified locations.

The installer is responsible for conformance to all applicable codes.

- * The device must be installed following the guidelines set forth in this installation guide, or the inherent protection provided by the device may be compromised.
- * When installed in an outdoor or harsh environment, the device must be mounted in an appropriate listed outdoor or industrial rated enclosure (Type 4X / IP54 in Europe).
- Only copper wiring is to be used for all field wiring terminals.
- Leviton strongly believes in continuous improvement, therefore we must reserve the right to change specifications and product offerings without notice. Where possible, we will substitute products with equivalent functionality when necessary.

2 OVERVIEW

EMB Hub is a family of data acquisition servers which provides owners and managers of commercial and industrial facilities with a cost-effective means of gathering crucial information in a timely manner. The EMB footprint and industrial temperature range makes this a perfect solution for embedded applications. Reduce development time and speed up integration by collecting and distributing energy information directly from your equipment.

| SPECIFICATIONS | |
|-------------------------|--|
| Power | 24VDC, 500mA max |
| Polution Degree | 2 |
| Operating Temperature | -22°F (-30°C) to +158°F (70°C), 95% RH non-condensing |
| Communication Protocols | Modbus RTU, Modbus TCP, TCP/IP, HTTP, HTML, FTP LAN: RJ45, 10/100 Ethernet USB: USB 2.0 Type A RS485: Single (1x) RS485 Modbus (32 devices total) |
| Torque Settings | (Wiring Terminals) Min = 4.4 in/lb (0.5 NM) Max = 5.3 in/lb (0.6 NM) |

3 INSTALLATION CHECKLIST

Hardware:

- A Data Acquisition Server (DAS¹)
- Laptop (not provided) with one RJ45 port (required for LAN or direct laptop-to-EMB Hub connection)
- Ethernet Cat 5 or better ethernet cable (not provided)
- Power Supply 24VDC, 500mA or greater (not provided)

Optional hardware:

- Additional Modbus™ Devices or BACnet Devices.
- 2 wire, twisted pair with shield for Modbus/RS485 connection (Belden™ 1120A or equivalent).
- Termination resistor (120 ohm) for long RS485 runs over 200 ft.

¹ Data Acquisition Server (A8810 EMB Hub, A7810 EMB HubLite, and A8812 EMH)

4 HARDWARE AND ELECTRICAL CONNECTION DIAGRAM

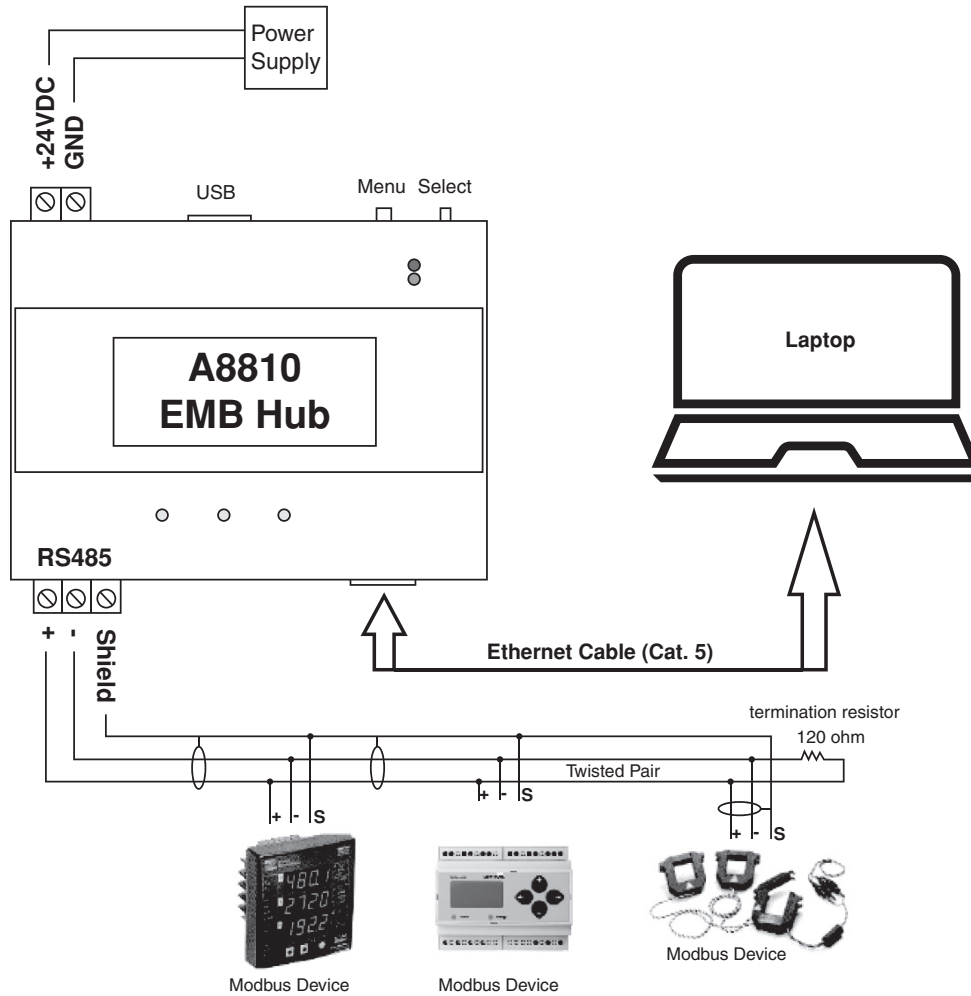

Figure 1

1. Unpack materials.
2. Mount the DAS using either the din rail mount, or with screws through the mounting tabs.
Note: A8812 & A8814 are not DIN rail compatible.
3. (Optional) Connect the Modbus network loop as shown in the above diagram. Follow the manufacturer's instructions for installing and powering the Modbus devices.
4. Connect a PC to the DAS using a Cat 5 or better ethernet cable. (Figure 1)
5. Supply +24VDC to the DAS. After power is applied the "Alive" light (upper right of A8810 and A7810) will turn on and the LCD display will display series of diagnostics screens.
6. Decide type of connection
 - a. DHCP Mode (Default)
 - b. Static IP Mode

5 DHCP ENABLED MODE

Confirm the DAS is properly connected to the computer or a LAN, and both are powered on.

1. Confirm that DHCP is enabled on the computer. For most computers, this is the default setting.
2. To confirm you have established connection to the device, do a ping to the IP address shown in the DAS's LCD display. If no packets were lost, the connection is working and you are ready to proceed.
3. Open a browser and type the IP address, shown on the LCD display of the EMB Hub, in the address bar.
4. This will open the web browser interface of the EMB Hub.
5. At initial setup a password must be created. Click on the “click here for Password Setup” to create the admin user password.

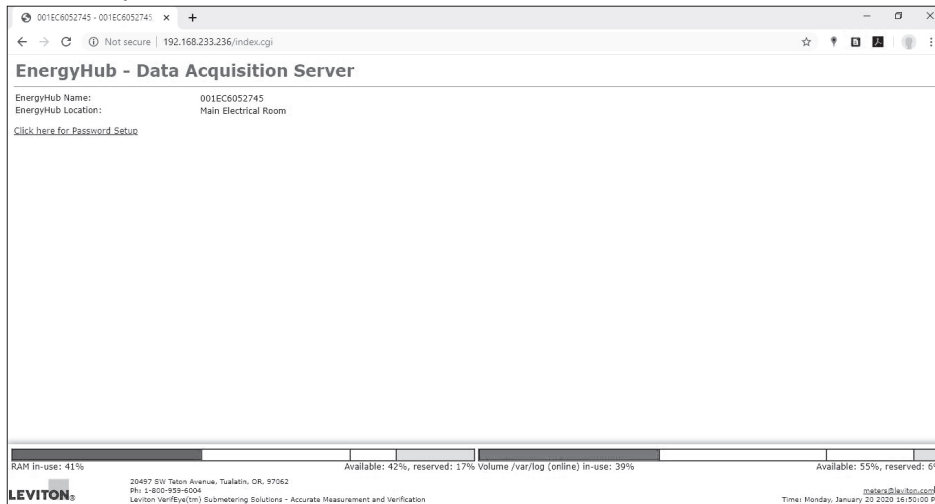

Figure 2

6. Enter the desired admin user password in both boxes and click the Apply button.

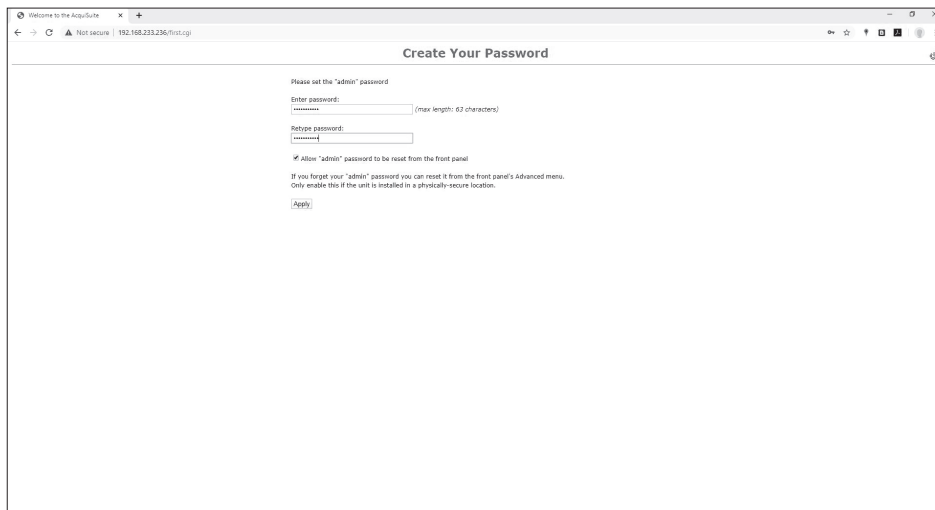

Figure 3

7. A Thank You message will be displayed, confirming that the password was successfully set. Click on the line below to proceed to the login screen.

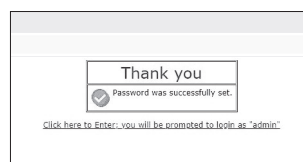

Figure 4

6 STATIC IP MODE

Confirm the DAS is properly connected to the computer, and both are powered on.

1. On the EMB Hub, click the “Menu” button to select the “TCP/IP Config” option.
2. Click the “Select” button to enter the “TCP/IP Menu.”
3. Select the “DHCP+UPnP on/off” option by scrolling through options using the “Menu” button and using “Select” button to enter.
4. Disable the DHCP+UPnP by clicking the “Menu” button, and navigating back to the “TCP/IP Config” Menu.
5. Scroll through options (using “Menu” button) and select “IP Address” option using the “Select” Button.
6. Confirm the IP address is 192.168.40.50
7. Scroll through the menu options and select “Previous Menu;” to return to the home menu options. This change will require a reboot.
8. Click “Select” button to execute the reboot.
The DAS default network configuration is:
 - a. IP Address: 192.168.40.50
 - b. Netmask: 255.255.255.0
 - c. Gateway: 192.168.40.1
9. Configure the computer with the following static IP settings:
 - a. IP Address: 192.168.40.1
 - b. Netmask: 255.255.255.0
 - c. Gateway: 192.168.40.1
10. Open a browser and type the IP address, shown on the LCD display of the EMB Hub, on the address bar.
11. This will open the web browser interface of the EMB Hub.
12. At initial setup a password must be created. Click on the “click here for Password Setup” to create the admin user password.

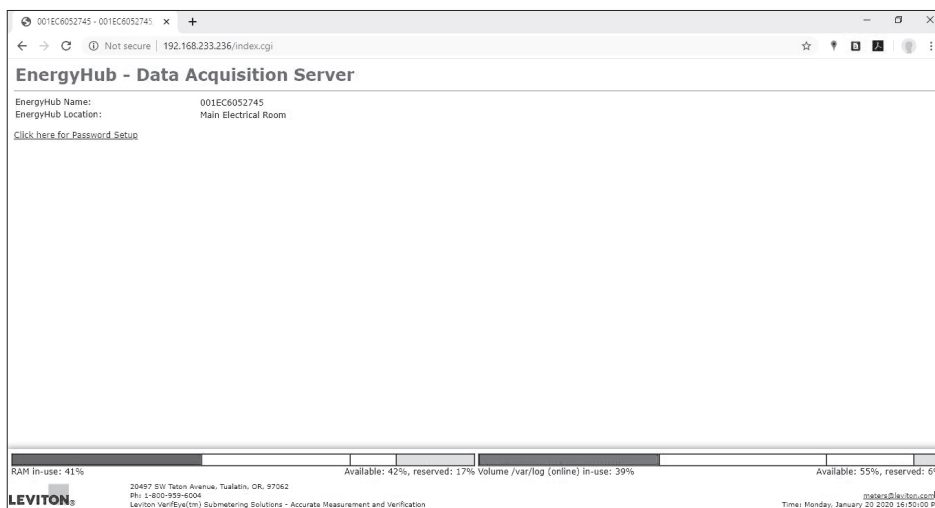
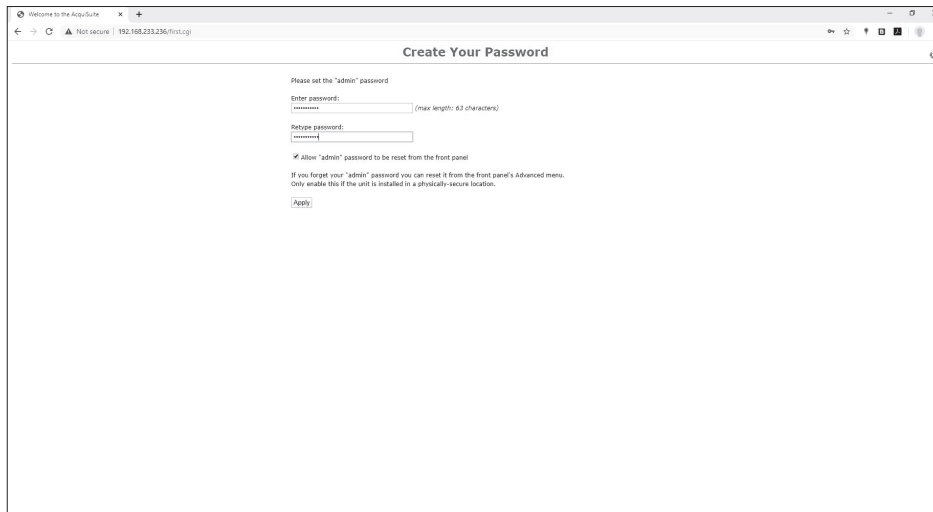

Figure 5

6 STATIC IP MODE

13. Enter the desired admin user password in both boxes and click the Apply button.



The screenshot shows a web browser window with the address bar displaying "192.168.223.236/first.cgi". The page title is "Create Your Password". The main content area contains the following text and form elements:

- "Please set the 'admin' password"
- "Enter password:" followed by a text input field and "(min length: 63 characters)"
- "Retype password:" followed by a text input field
- A checked checkbox: "Allow 'admin' password to be reset from the front panel"
- Small text: "If you forget your 'admin' password you can reset it from the front panel's Advanced menu. Only enable this if the unit is installed in a physically-secure location."
- An "Apply" button

Figure 6

14. A Thank You message will be displayed, confirming that the password was successfully set. Click on the line below to proceed to the login screen.

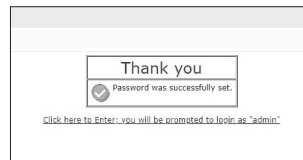
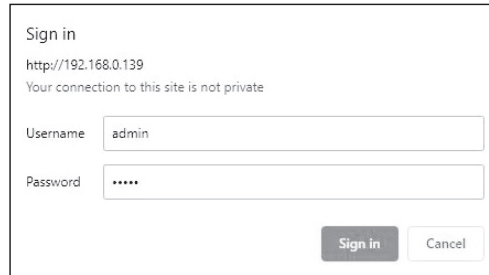

Figure 7

7 LOGGING INTO THE EMB HUB

1. From the web browser interface, click on “Click here to enter.”
2. Enter the username and password.



Sign in

http://192.168.0.139
Your connection to this site is not private

Username

Password

3. Click “Sign in.”

Figure 8

4. Login successful.

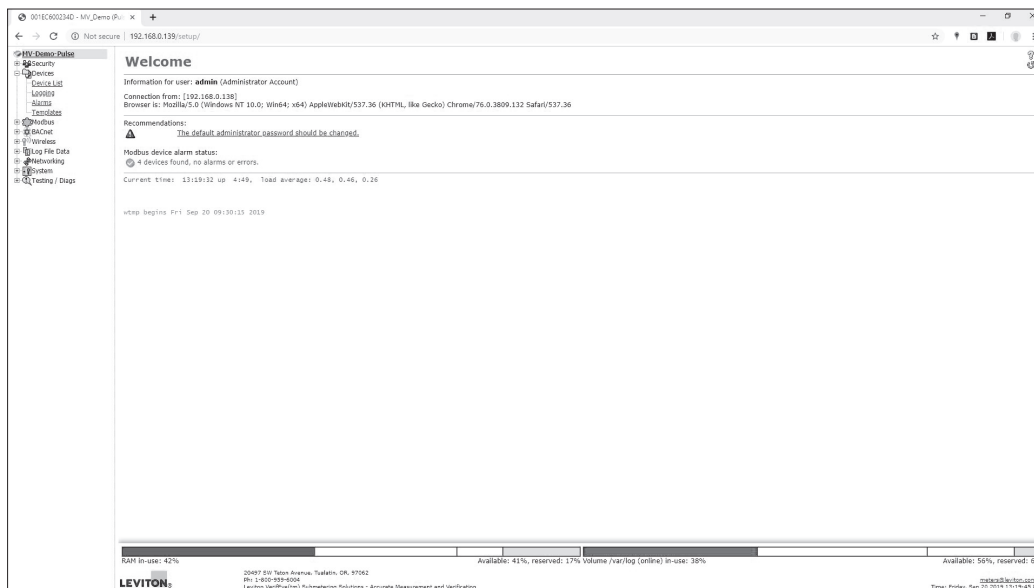

Figure 9

8 WARRANTY AND CONTACT INFORMATION

FCC STATEMENT:

This equipment has been tested and found to comply with the limits for a Class A digital device, pursuant to Part 15 of the FCC Rules. These limits are designed to provide reasonable protection against harmful interference when the equipment is operated in a commercial environment. This equipment generates, uses, and can radiate radio frequency energy and, if not installed and used in accordance with the instruction manual, may cause harmful interference to radio communications. Operation of this equipment in a residential area is likely to cause harmful interference in which case the user will be required to correct the interference at his own expense.

Any changes or modifications not expressly approved by Leviton Manufacturing Co., could void the user's authority to operate the equipment.

FCC SUPPLIERS DECLARATION OF CONFORMITY (SDOC):

Model A8810 manufactured by Leviton Manufacturing Co., Inc., 201 North Service Road, Melville, NY 11747, www.leviton.com. This device complies with Part 15 of the FCC Rules. Operation is subject to the following two conditions: (1) This device may not cause harmful interference, and (2) this device must accept any interference received, including interference that may cause undesired operation.

IC STATEMENT:

This device complies with Industry Canada license-exempt RSS standard(s). Operation is subject to the following two conditions: (1) this device may not cause interference, and (2) this device must accept any interference, including interference that may cause undesired operation of the device.

TRADEMARK DISCLAIMER:

Use herein of third party trademarks, service marks, trade names, brand names and/or product names are for informational purposes only, are/may be the trademarks of their respective owners; such use is not meant to imply affiliation, sponsorship, or endorsement. Modbus is a U.S. registered trademark of Schneider Electric USA, Inc. Belden is a trademark of Belden, Inc.

Leviton Manufacturing Co., Inc.
201 North Service Road, Melville, NY 11747

Visit Leviton's website at www.leviton.com

© 2024 Leviton Manufacturing Co., Inc. All rights reserved.

Specifications and price subject to change at any time without notice.

FOR CANADA ONLY

For warranty information and/or product returns, residents of Canada should contact Leviton in writing at **Leviton Manufacturing of Canada ULC** to the **attention of the Quality Assurance Department, 165 Hymus Blvd, Pointe-Claire (Quebec), Canada H9R 1E9** or by telephone at **1-800-405-5320**.

LIMITED 5 YEAR WARRANTY AND EXCLUSIONS

Leviton warrants to the original consumer purchaser and not for the benefit of anyone else that this product at the time of its sale by Leviton is free of defects in materials and workmanship under normal and proper use for five years from the purchase date. Leviton's only obligation is to correct such defects by repair or replacement, at its option. **For details visit www.leviton.com or call 1-800-824-3005.** This warranty excludes and there is disclaimed liability for labor for removal of this product or reinstallation. This warranty is void if this product is installed improperly or in an improper environment, overloaded, misused, opened, abused, or altered in any manner, or is not used under normal operating conditions or not in accordance with any labels or instructions. **There are no other or implied warranties of any kind, including merchantability and fitness for a particular purpose,** but if any implied warranty is required by the applicable jurisdiction, the duration of any such implied warranty, including merchantability and fitness for a particular purpose, is limited to five years. **Leviton is not liable for incidental, indirect, special, or consequential damages, including without limitation, damage to, or loss of use of, any equipment, lost sales or profits or delay or failure to perform this warranty obligation.** The remedies provided herein are the exclusive remedies under this warranty, whether based on contract, tort or otherwise.

For Technical Assistance Call: 1-800-824-3005 (USA Only) or 1-800-405-5320 (Canada Only) www.leviton.com

